

Keystone RJ45 socket cat. 6

Cat. No(s): 0 331 81

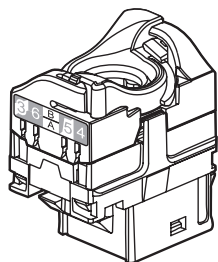

UTP

CONTENTS

Page

1. General characteristics	1
2. Presentation	1
3. Technical characteristics	1
4. Overall dimensions	1
5. Usual connection of RJ45 sockets	2
6. Standards and approvals	2
7. Performance	3-4

1. GENERAL CHARACTERISTICS

Category 6 RJ45 socket.
 Enables high speed data transmission (Gigabit Ethernet).

2. PRESENTATION

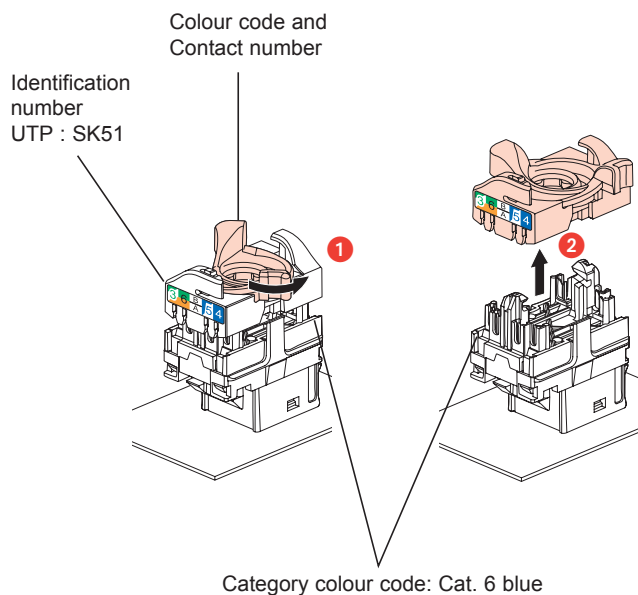

3. TECHNICAL CHARACTERISTICS

- 3.1 Material characteristics
 Contacts: gold/nickel, thickness of gold > 0.8 µm min.
 Metal parts: bronze, nickel, platinum, gold
 PBT polycarbonate
- 3.2 Electrical characteristics
 Breakdown voltage ≥ 1000 V.
 Contact resistance ≤ 20 mΩ.
 Insulation resistance ≥ 500 MΩ at 100 V DC.
 Compatible remote powering "PoE" up to 100w. (IEEE 802.3af, IEEE 802.3at, IEEE 802.3bt)
- 3.3 Mechanical characteristics
 Max. number of connections and disconnections: 5 without refreshing the cable
 Endurance: 2500 movements (plug insertion/withdrawal)
 IK03
- 3.4 Climatic characteristics
 Operating temperature: - 40°C to + 70°C
 Humid heat cycle 21 days

4. OVERALL DIMENSIONS

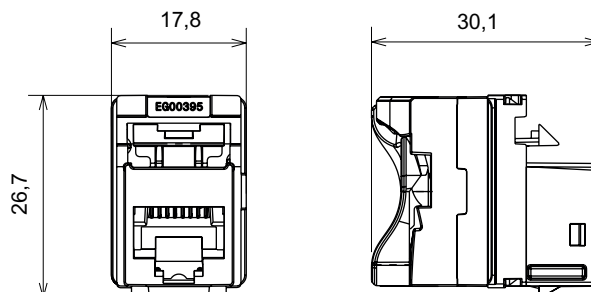

5. USUAL CONNECTION OF RJ45 SOCKETS

Accepts the following cable connectors:
 RJ11 (4 contacts), RJ12 (6 contacts), RJ45 (9 contacts).
 Double colour code EIA - TIA 568 A and B on terminals:
 - UTP 8 contacts

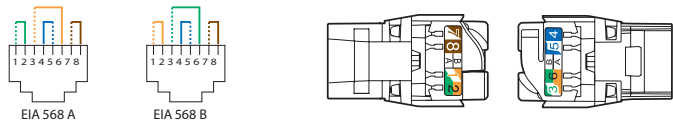

Conductors supported:
 - Single-core/Multicore: 0.4 to 0.65 mm, AWG 26 to 22
 - Polyethylene conductor insulation: Ø 0.85 to 1.7 mm on insulation
 The RJ45 connectors are equipped with a rotating locking system that does not require special tools and enables rewiring in the event of error.

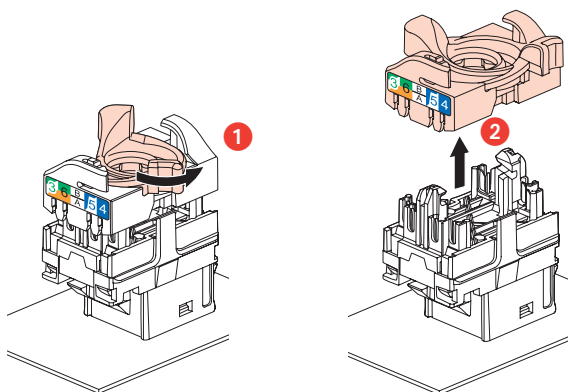

This system allows the wire pairs to be spread easily before attaching them to the connector.

Spreading the wires ensures that pairs are separated by the required 13 mm.
 Spreading the pairs at 90° in relation to the cable ensures the best performance levels.

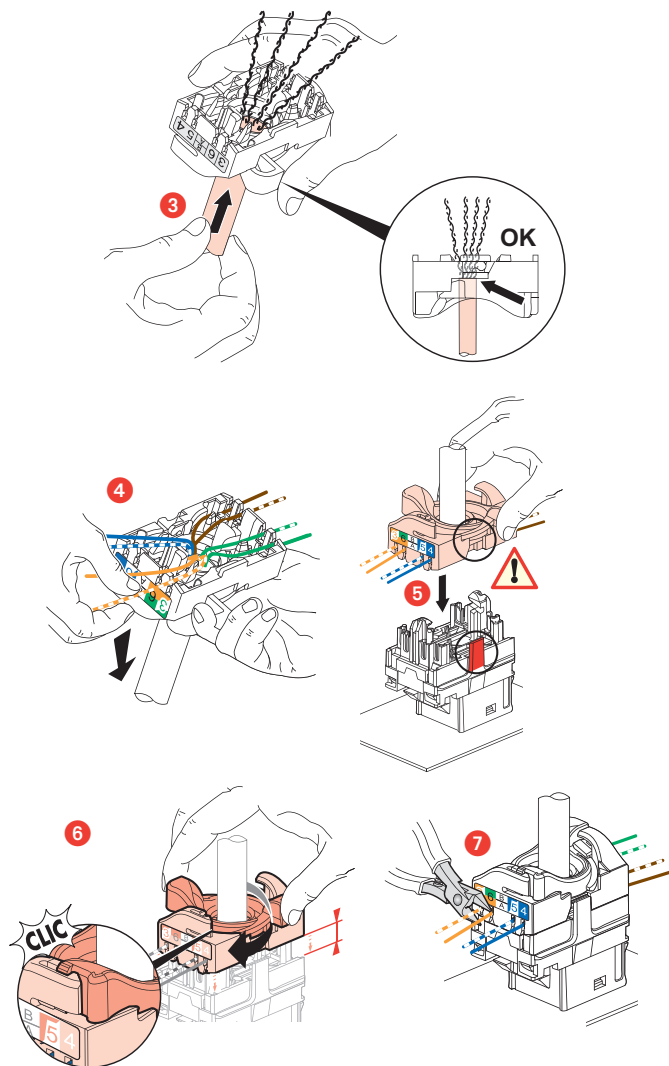

6. STANDARDS AND APPROVALS

Conforms to standards: ISO/IEC 11801 Edition 2
 CENELEC EN 50173-1 2007
 ANSI/TIA 568.2-D
 IEC series 60603-7
 IEEE 802.3bt : PoE++

7. PERFORMANCE

7.1 Component performance (RJ45 connectors)

Return loss

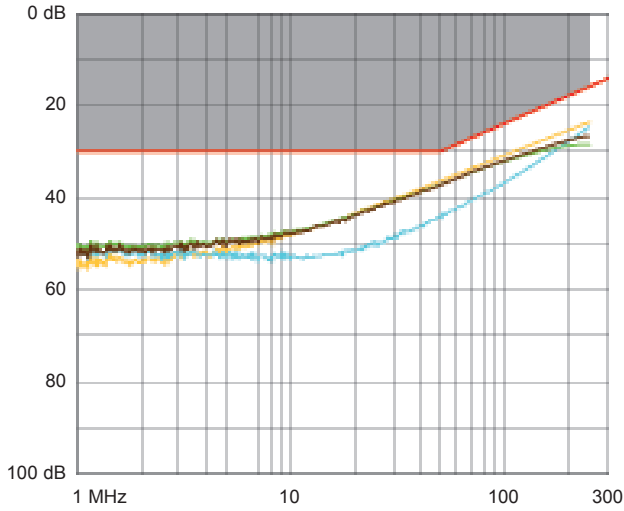

Attenuation

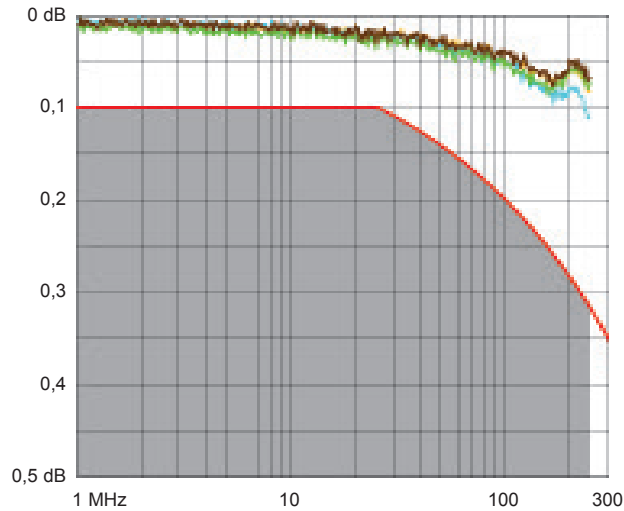

NEXT (Near end Crosstalk Attenuation)

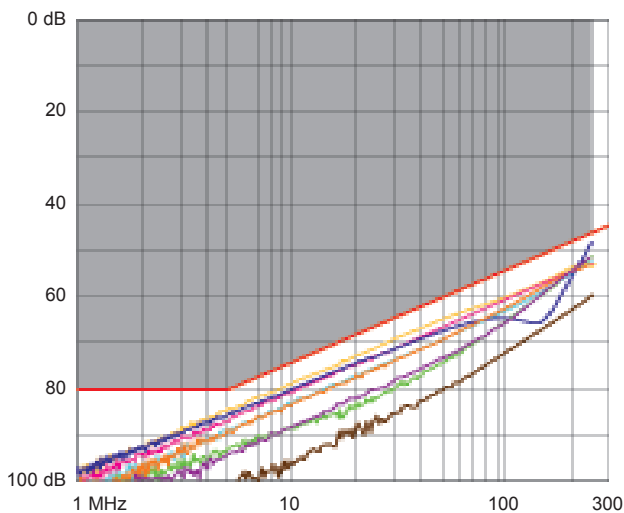

7. PERFORMANCE (cont.)

7.1 Component performance (RJ45 connectors) (cont.)

FEXT (Far end Crosstalk Attenuation)

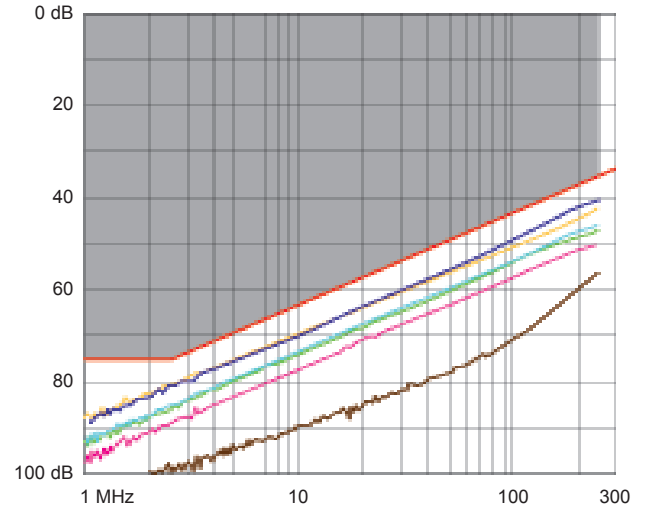

7.2 Permanent link performance with F/UTP cable

Return loss

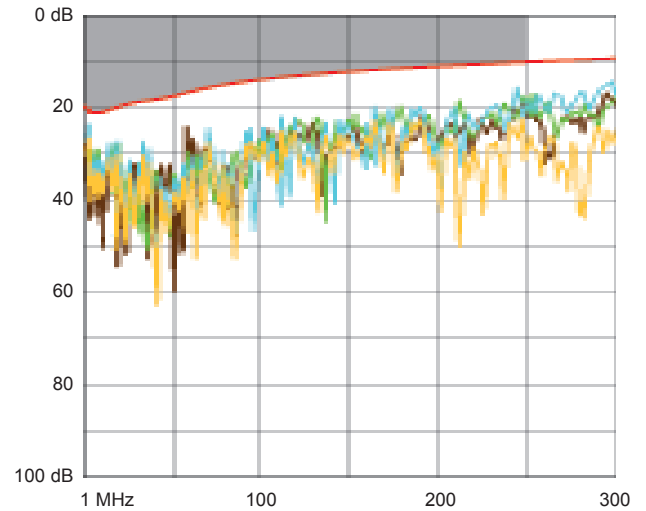

Attenuation

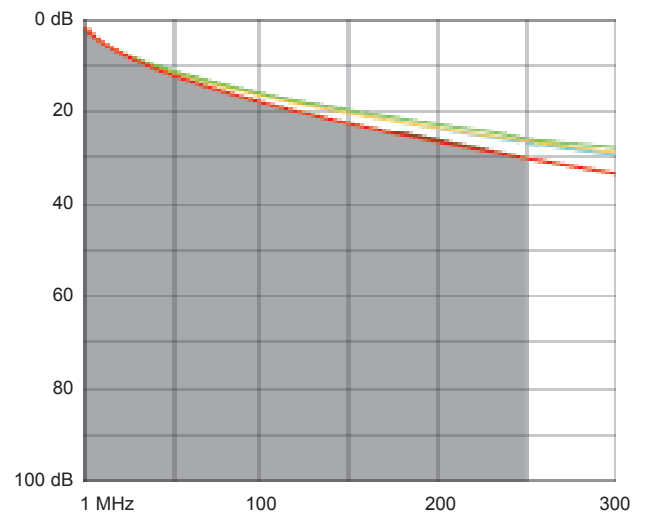

7. PERFORMANCE (cont.)

7.2 Permanent link performance with F/UTP cable (cont.) NEXT (Near end Crosstalk Attenuation)

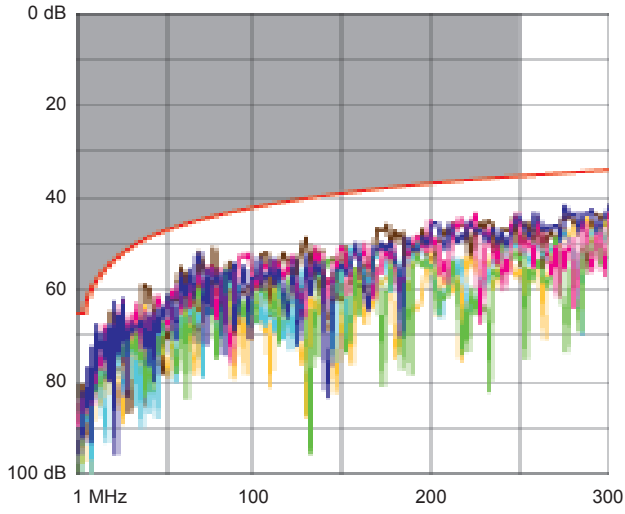

PS NEXT (Power Sum NEXT)

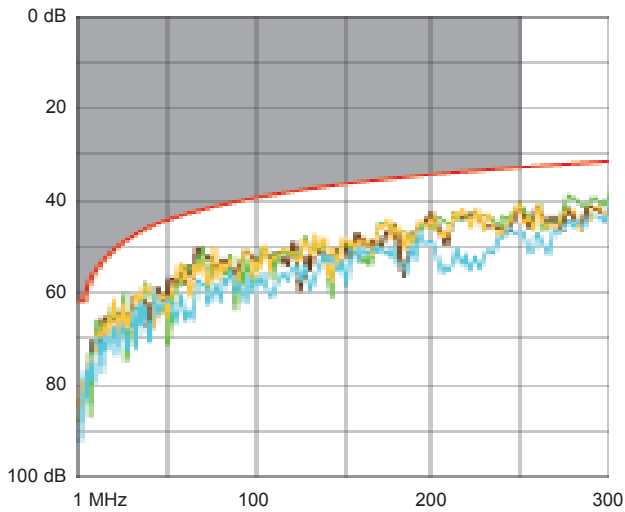

ACR (Attenuation to Crosstalk Ratio)

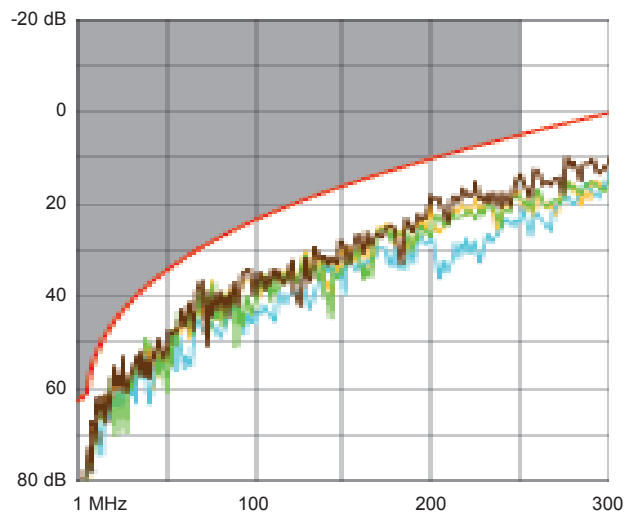

7. PERFORMANCE (cont.)

7.2 Permanent link performance with F/UTP cable (cont.) ELFEXT (Equal Level End Crosstalk Attenuation)

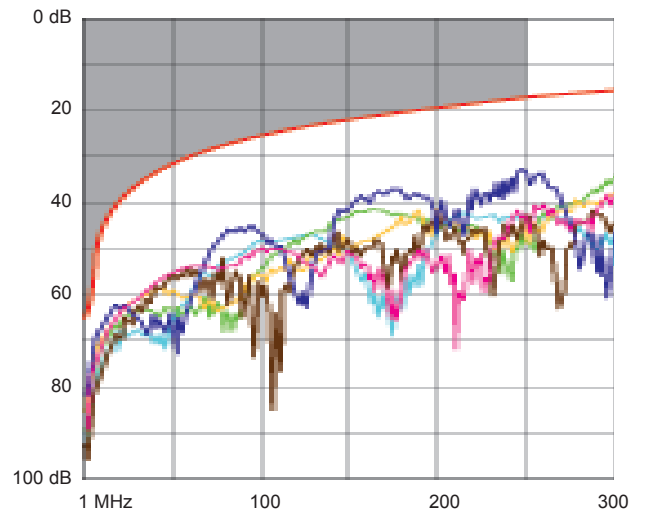

Delay skew

